

**Applications**

- Switch Mode Power Supply (SMPS)
- Uninterruptable Power Supply
- High Speed Power Switching

<b>V<sub>DSS</sub></b>	<b>R<sub>DS(on)</sub> max</b>	<b>I<sub>D</sub></b>
<b>500V</b>	<b>0.13Ω</b>	<b>36A</b>

**Benefits**

- Low Gate Charge Qg results in Simple Drive Requirement
- Improved Gate, Avalanche and Dynamic dv/dt Ruggedness
- Fully Characterized Capacitance and Avalanche Voltage and Current
- Effective Coss Specified (See AN 1001)



**Absolute Maximum Ratings**

	<b>Parameter</b>	<b>Max.</b>	<b>Units</b>
I <sub>D</sub> @ T <sub>C</sub> = 25°C	Continuous Drain Current, V <sub>GS</sub> @ 10V	36	A
I <sub>D</sub> @ T <sub>C</sub> = 100°C	Continuous Drain Current, V <sub>GS</sub> @ 10V	23	
I <sub>DM</sub>	Pulsed Drain Current ①	144	
P <sub>D</sub> @ T <sub>C</sub> = 25°C	Power Dissipation	446	W
	Linear Derating Factor	3.6	W/°C
V <sub>GS</sub>	Gate-to-Source Voltage	± 30	V
dv/dt	Peak Diode Recovery dv/dt ③	3.5	V/ns
T <sub>J</sub>	Operating Junction and	-55 to + 150	°C
T <sub>STG</sub>	Storage Temperature Range		
	Soldering Temperature, for 10 seconds	300 (1.6mm from case )	

**Typical SMPS Topologies**

- Full Bridge Converters
- Power Factor Correction Boost

# IRFPS37N50A

International  
IR Rectifier

Static @  $T_J = 25^\circ\text{C}$  (unless otherwise specified)

	Parameter	Min.	Typ.	Max.	Units	Conditions
$V_{(BR)DSS}$	Drain-to-Source Breakdown Voltage	500	—	—	V	$V_{GS} = 0V, I_D = 250\mu A$
$R_{DS(on)}$	Static Drain-to-Source On-Resistance	—	—	0.13	$\Omega$	$V_{GS} = 10V, I_D = 22A$ ④
$V_{GS(th)}$	Gate Threshold Voltage	2.0	—	4.0	V	$V_{DS} = V_{GS}, I_D = 250\mu A$
$I_{DSS}$	Drain-to-Source Leakage Current	—	—	25	$\mu A$	$V_{DS} = 500V, V_{GS} = 0V$
		—	—	250		$V_{DS} = 400V, V_{GS} = 0V, T_J = 150^\circ\text{C}$
$I_{GSS}$	Gate-to-Source Forward Leakage	—	—	100	nA	$V_{GS} = 30V$
	Gate-to-Source Reverse Leakage	—	—	-100		$V_{GS} = -30V$

Dynamic @  $T_J = 25^\circ\text{C}$  (unless otherwise specified)

	Parameter	Min.	Typ.	Max.	Units	Conditions
$g_{fs}$	Forward Transconductance	20	—	—	S	$V_{DS} = 50V, I_D = 22A$
$Q_g$	Total Gate Charge	—	—	180	nC	$I_D = 36A$ $V_{DS} = 400V$ $V_{GS} = 10V$ , See Fig. 6 and 13 ④
$Q_{gs}$	Gate-to-Source Charge	—	—	46		
$Q_{gd}$	Gate-to-Drain ("Miller") Charge	—	—	71		
$t_{d(on)}$	Turn-On Delay Time	—	23	—	ns	$V_{DD} = 250V$ $I_D = 36A$ $R_G = 2.15\Omega$ $R_D = 7.0\Omega$ , See Fig. 10 ④
$t_r$	Rise Time	—	98	—		
$t_{d(off)}$	Turn-Off Delay Time	—	52	—		
$t_f$	Fall Time	—	80	—		
$C_{iss}$	Input Capacitance	—	5579	—	pF	$V_{GS} = 0V$ $V_{DS} = 25V$ $f = 1.0\text{MHz}$ , See Fig. 5
$C_{oss}$	Output Capacitance	—	810	—		
$C_{rss}$	Reverse Transfer Capacitance	—	36	—		
$C_{oss}$	Output Capacitance	—	7905	—		
$C_{oss}$	Output Capacitance	—	221	—		
$C_{oss\ eff.}$	Effective Output Capacitance	—	400	—		
						$V_{GS} = 0V, V_{DS} = 0V \text{ to } 400V$ ⑤

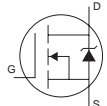
## Avalanche Characteristics

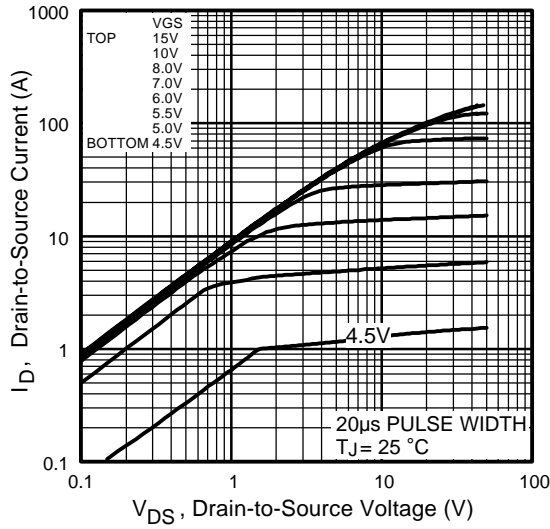
	Parameter	Typ.	Max.	Units
$E_{AS}$	Single Pulse Avalanche Energy②	—	1260	mJ
$I_{AR}$	Avalanche Current①	—	36	A
$E_{AR}$	Repetitive Avalanche Energy①	—	44	mJ

## Thermal Resistance

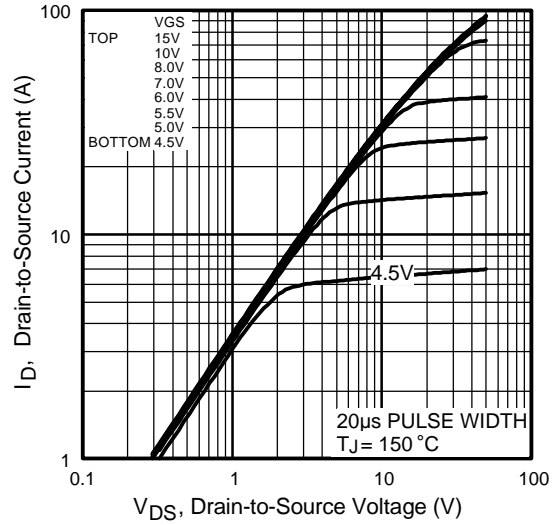
	Parameter	Typ.	Max.	Units
$R_{\theta JC}$	Junction-to-Case	—	0.28	$^\circ\text{C/W}$
$R_{\theta CS}$	Case-to-Sink, Flat, Greased Surface	0.24	—	
$R_{\theta JA}$	Junction-to-Ambient	—	40	

## Diode Characteristics

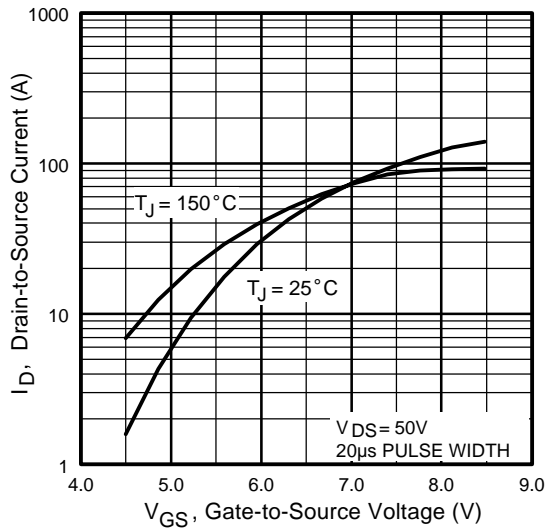
	Parameter	Min.	Typ.	Max.	Units	Conditions
$I_S$	Continuous Source Current (Body Diode)	—	—	36	A	MOSFET symbol showing the integral reverse p-n junction diode. 
$I_{SM}$	Pulsed Source Current (Body Diode) ①	—	—	144		
$V_{SD}$	Diode Forward Voltage	—	—	1.5	V	$T_J = 25^\circ\text{C}, I_S = 36A, V_{GS} = 0V$ ④
$t_{rr}$	Reverse Recovery Time	—	570	860	ns	$T_J = 25^\circ\text{C}, I_F = 36A$
$Q_{rr}$	Reverse Recovery Charge	—	8.6	13	$\mu\text{C}$	$di/dt = 100A/\mu\text{s}$ ④
$t_{on}$	Forward Turn-On Time	Intrinsic turn-on time is negligible (turn-on is dominated by $L_S+L_D$ )				



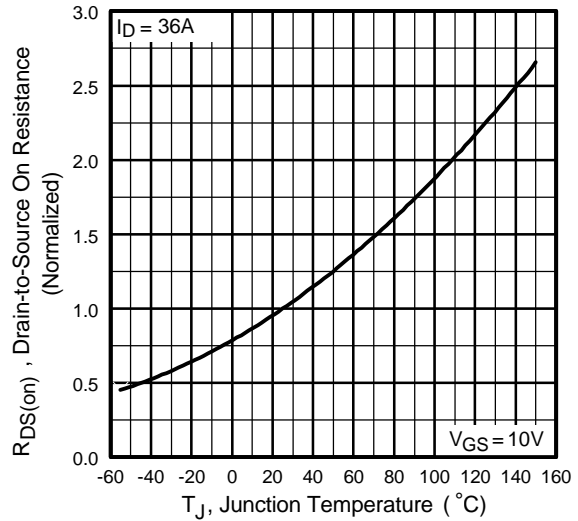
**Fig 1.** Typical Output Characteristics



**Fig 2.** Typical Output Characteristics

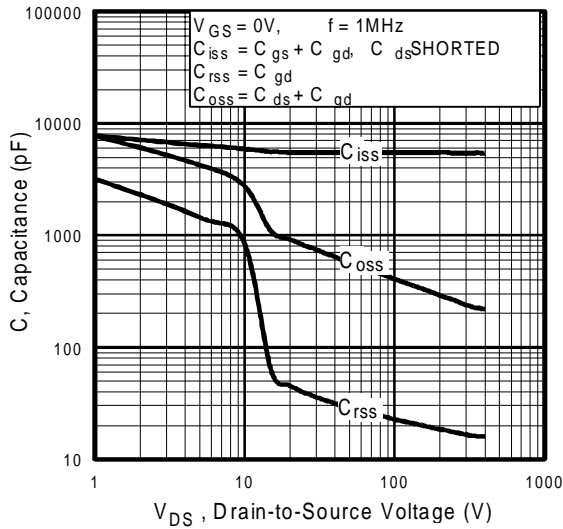


**Fig 3.** Typical Transfer Characteristics

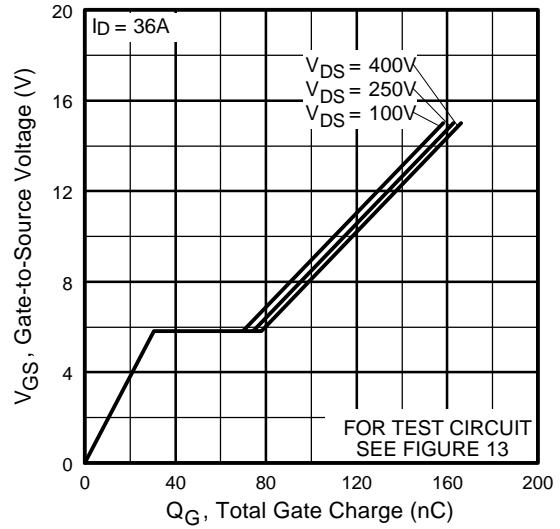


**Fig 4.** Normalized On-Resistance Vs. Temperature

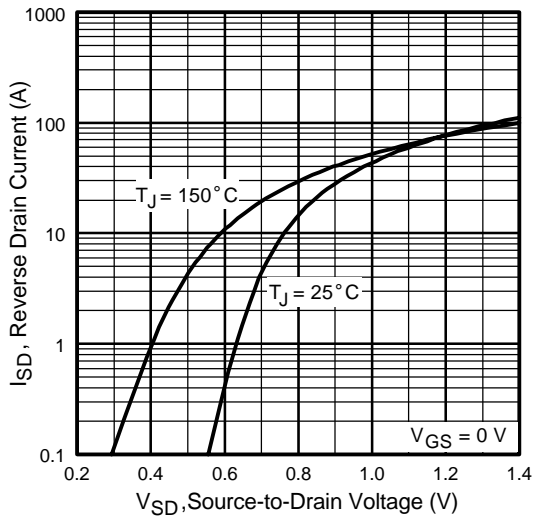
# IRFPS37N50A



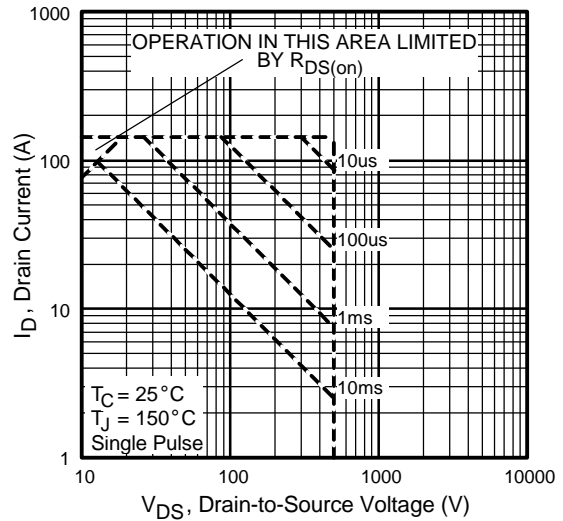
**Fig 5.** Typical Capacitance Vs. Drain-to-Source Voltage



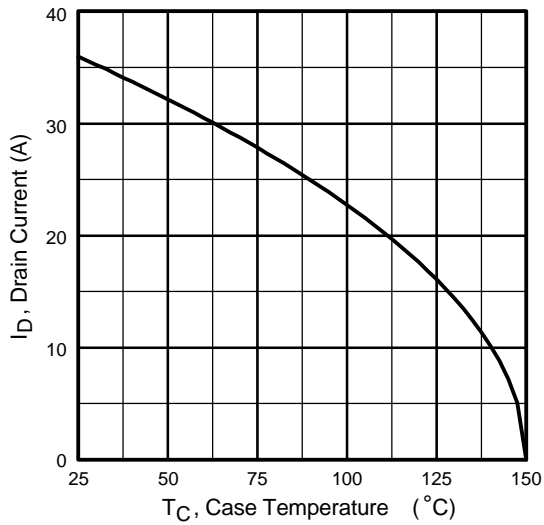
**Fig 6.** Typical Gate Charge Vs. Gate-to-Source Voltage



**Fig 7.** Typical Source-Drain Diode Forward Voltage



**Fig 8.** Maximum Safe Operating Area



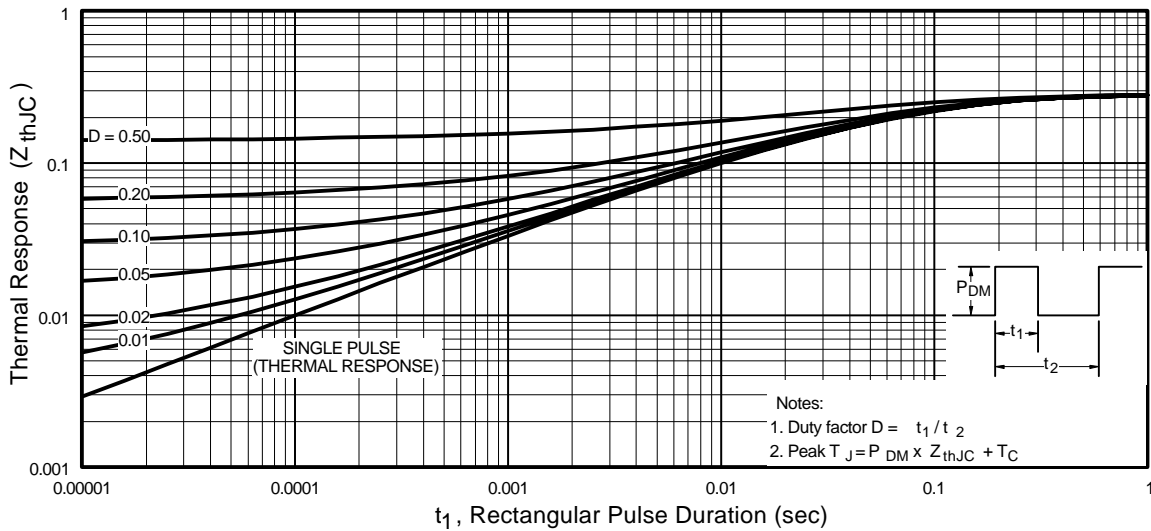
**Fig 9.** Maximum Drain Current Vs. Case Temperature



**Fig 10a.** Switching Time Test Circuit



**Fig 10b.** Switching Time Waveforms



**Fig 11.** Maximum Effective Transient Thermal Impedance, Junction-to-Case

# IRFPS37N50A

International  
**IR** Rectifier



**Fig 12a.** Unclamped Inductive Test Circuit



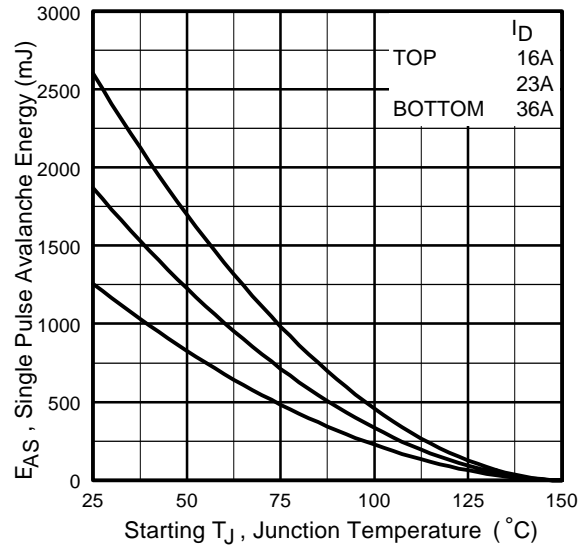
**Fig 12b.** Unclamped Inductive Waveforms



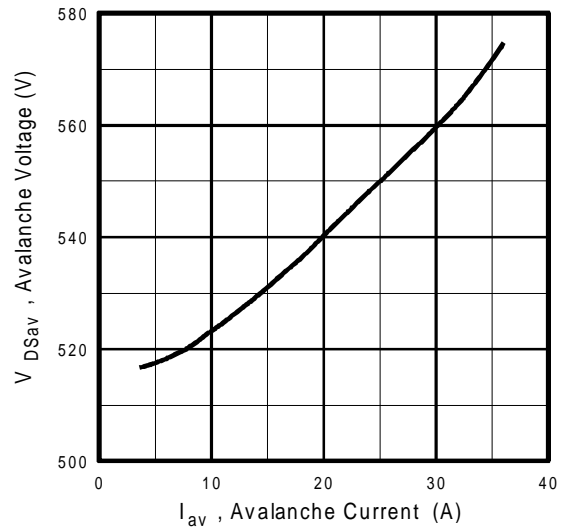
**Fig 13a.** Basic Gate Charge Waveform



**Fig 13b.** Gate Charge Test Circuit



**Fig 12c.** Maximum Avalanche Energy Vs. Drain Current



**Fig 12d.** Typical Drain-to-Source Voltage Vs. Avalanche Current

## Peak Diode Recovery dv/dt Test Circuit



\*  $V_{GS} = 5V$  for Logic Level Devices

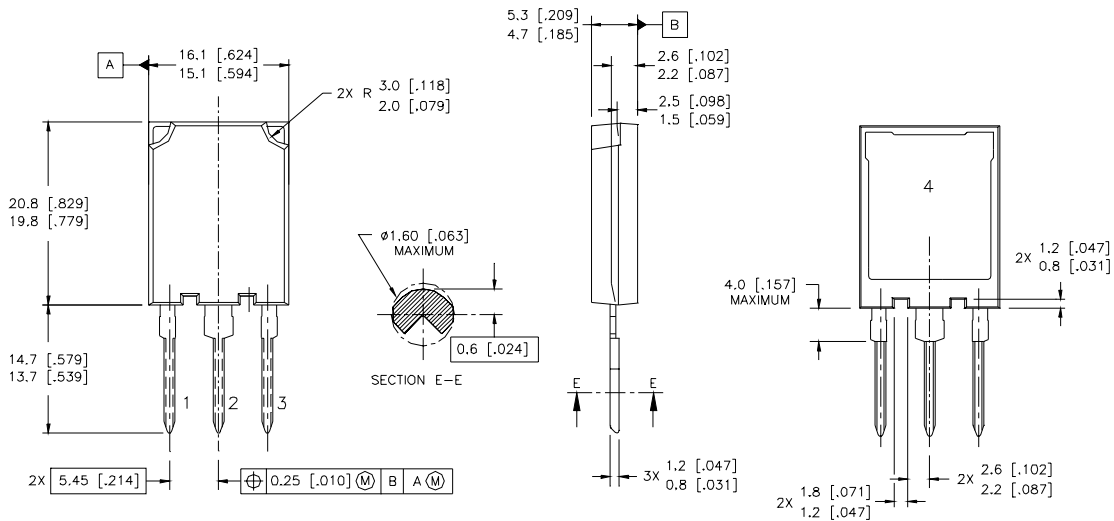
**Fig 14.** For N-channel HEXFET® Power MOSFETs

# IRFPS37N50A

International  
**IR** Rectifier

## Case Outline and Dimensions — Super-247

Dimensions are shown in millimeters



### NOTES:

1. DIMENSIONS & TOLERANCING PER ASME Y14.5M-1994
2. CONTROLLING DIMENSION: MILLIMETER
3. DIMENSIONS ARE SHOWN IN MILLIMETRES [INCHES]

### LEAD ASSIGNMENTS

MOSFET	IGBT
1 - GATE	1 - GATE
2 - DRAIN	2 - COLLECTOR
3 - SOURCE	3 - EMITTER
4 - DRAIN	4 - COLLECTOR

### Notes:

- ① Repetitive rating; pulse width limited by max. junction temperature. ( See fig. 11 )
  - ② Starting  $T_J = 25^\circ\text{C}$ ,  $L = 1.94\text{mH}$   
 $R_G = 25\Omega$ ,  $I_{AS} = 36\text{A}$ . (See Figure 12)
  - ③  $I_{SD} \leq 36\text{A}$ ,  $di/dt \leq 145\text{A}/\mu\text{s}$ ,  $V_{DD} \leq V_{(BR)DSS}$ ,  
 $T_J \leq 150^\circ\text{C}$
  - ④ Pulse width  $\leq 300\mu\text{s}$ ; duty cycle  $\leq 2\%$ .
  - ⑤  $C_{OSS}$  eff. is a fixed capacitance that gives the same charging time as  $C_{OSS}$  while  $V_{DS}$  is rising from 0 to 80%  $V_{DSS}$
- \*\* When mounted on 1" square PCB (FR-4 or G-10 Material ) .  
For recommended footprint and soldering techniques refer to application note #AN-994

International  
**IR** Rectifier

**WORLD HEADQUARTERS:** 233 Kansas St., El Segundo, California 90245, Tel: (310) 252-7105

**IR GREAT BRITAIN:** Hurst Green, Oxted, Surrey RH8 9BB, UK Tel: ++ 44 1883 732020

**IR CANADA:** 15 Lincoln Court, Brampton, Ontario L6T3Z2, Tel: (905) 453 2200

**IR GERMANY:** Saalburgstrasse 157, 61350 Bad Homburg Tel: ++ 49 6172 96590

**IR ITALY:** Via Liguria 49, 10071 Borgaro, Torino Tel: ++ 39 11 451 0111

**IR JAPAN:** K&H Bldg., 2F, 30-4 Nishi-Ikebukuro 3-Chome, Toshima-Ku, Tokyo Japan 171 Tel: 81 3 3983 0086

**IR SOUTHEAST ASIA:** 1 Kim Seng Promenade, Great World City West Tower, 13-11, Singapore 237994 Tel: ++ 65 838 4630

**IR TAIWAN:** 16 Fl. Suite D. 207, Sec. 2, Tun Haw South Road, Taipei, 10673, Taiwan Tel: 886-2-2377-9936

Data and specifications subject to change without notice. 12/99